

规格书

产品：LCD 模块

型号：S95192

客户			宇顺公司		
批准	审核	检查	批准	审核	拟制

用于承认规格书

用于承认规格书和样品

深圳市宇顺电子有限公司

SUCCESS ELECTRONIC CO., LTD.

标准文本	产品规格书	型号	S95192	页数	2
------	-------	----	--------	----	---

目录

1.	概述	-----	3
2.	产品特征	-----	3
3.	机械规格	-----	3
4.	外形尺寸	-----	4
5.	接口定义	-----	5
6.	应用电路	-----	6
7.	功能框图	-----	6
8.	接口时序	-----	7
9.	复位时序	-----	8
10.	上/下电时序	-----	9
11.	指令表	-----	10
12.	DDRAM 映射表	-----	11
13.	极限技术参数	-----	12
14.	电气参数	-----	12
15.	背光参数	-----	13
16.	光电参数	-----	14
17.	极限环境参数	-----	18
18.	可靠性测试	-----	18
19.	LCM 检验标准	-----	19
20.	LCM 的使用	-----	22

标准文本	产品规格书	型号	S95192	页数	3
------	-------	----	--------	----	---

1. 概述

1-1 范围:

此份规格书涵盖了 LCD 从字顺到客户的运输过程中应该注意的所有要求。

1-2 产品:

LCD 模块 (LCM)

1-3 型号:

S95192

2. 产品特征

- (1) 显示类型: 2.8" TFT, Transmissive, Normally white, 6 o'clock
- (2) 显示色彩: 65/262K
- (3) 背光模式: WHITE LED

3. 机械规格

项目	规格	单位
外形尺寸	50.00(L) x 98.7 (W) x 4.25(T)	mm
可视区域	43.2(L) x 57.6(W)	mm
显示内容	240RGB x320 Dots	---
分辨率	240 x3 x320	Dots
像素点尺寸	60 (L) x 180(W)	um
结构类型	COG+FPC+BL+TP	---
背光类型	WHTIE LED	—
重量	待定	g

4. 外形尺寸

PIN ASSIGNMENT

1	DB0
2	DB1
3	DB2
4	DB3
5	GN01
6	VCC1
7	/CS
8	RS
9	/WR
10	/RD
11	IM0
12	X+
13	Y+
14	X-
15	Y-
16	LEDA
17	LEDK1
18	LEDK2
19	LEDK3
20	LEDK4
21	IM3
22	DB4
23	DB10
24	DB11
25	DB12
26	DB13
27	DB14
28	DB15
29	DB16
30	DB17
31	/RESET
32	VCI
33	VCC2
34	GND
35	DB5
36	DB6
37	DB7

LED CIRCUIT DIAGRAM

NOTE:
 1. GENERAL TOLERANCE: ±0.2.
 2. (.) IS REFERENCE DIMENSION.
 3. COMPLIABLE RoHS.
 4. MAIN LCD DRIVER: IL19320

DRAWN		ME. CHECKED		DATE	
DE. CHECKED		PE. CHECKED		SIGN	2007-4-13
APPROVED		CUSTOMER'S APPROVAL			
AMENDMENT					

TFT	NORMAL WHITE	DRAWING NO.	STR-S95192	TITLE	MODULE SPEC.
TRANSMISSIVE	6.0° CLOCK	PROJECT NO.	S95192	VER.	01
Operating Voltage	VDD=2.8V	UNIT	mm	SCALE	PTT
Operation Temperature	-20°C TO 60°C	3rd Angle		SHEET	1 OF 1
Storage Temperature	-30°C TO 70°C				
Interface					
Backlight Color	WHITE				
Backlight Forward Voltage	Vf=3.2V(I _f =60mA)				

SUCCESS ELECTRONIC CO., LTD

5. 接口定义

PIN NO.	FUNCTION DESCRIPTIONS	SYMBOL
1	DATA BUS0	DB0
2	DATA BUS1	DB1
3	DATA BUS2	DB2
4	DATA BUS3	DB3
5	GROUND	GND1
6	CORRESPONDING LOW_VOLTAGE OPERATION	VCC1
7	Chip select signal. 0: chip can be accessed;	/CS
8	Command/display Data Selection	RS
9	I80 system : serves as a write signal and writes data at the rising edge.	/WR
10	I80 system: Serves as a read signal and reads data at the low level.	/RD
11	SELECT I80 SYSTEM INTERFACE PIN	IM0
12	T/P INTERFACE FOR X+	X+
13	T/P INTERFACE FOR Y+	Y+
14	T/P INTERFACE FOR X-	X-
15	T/P INTERFACE FOR Y-	Y-
16	B/L POWER PIN FOR LED_A	LED_A
17	B/L POWER PIN FOR LED_K1	LED_K1
18	B/L POWER PIN FOR LED_K2	LED_K2
19	B/L POWER PIN FOR LED_K3	LED_K3
20	B/L POWER PIN FOR LED_K4	LED_K4
21	SELECT C86 SYSTEM INTERFACE PIN	IM3
22	DATA BUS4	DB4
23	DATA BUS8	DB10
24	DATA BUS9	DB11
25	DATA BUS10	DB12
26	DATA BUS11	DB13
27	DATA BUS12	DB14
28	DATA BUS13	DB15
29	DATA BUS14	DB16
30	DATA BUS15	DB17
31	RESET PIN	/RESET
32	INTERNAL REFERANCE VOLTAGE	VCI
33	INTERFACE I/O OPERATION	VCC2
34	GROUND	GND
35	DATA BUS5	DB5
36	DATA BUS6	DB6
37	DATA BUS7	DB7

6. 应用电路

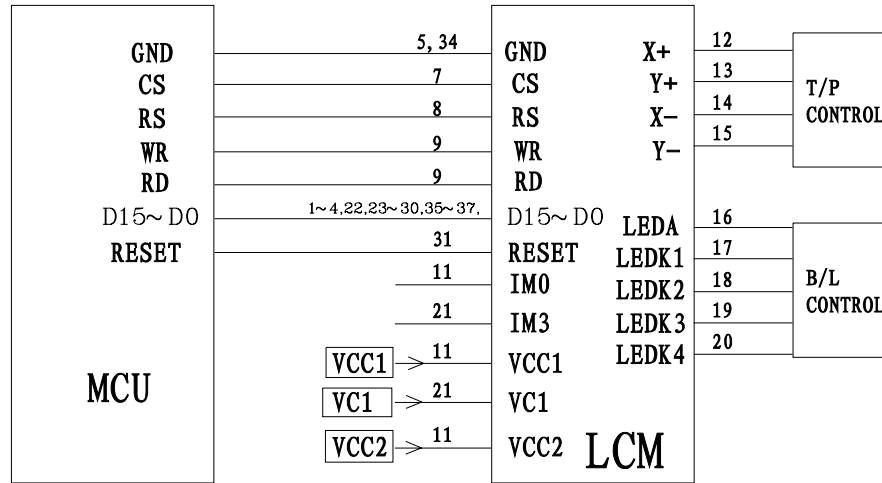

IM3	IM0	MODE
L	L	I80 system DB0~15 16-bit parallel
L	H	I80 system DB0~7 8-bit parallel (connect unused pings to gnd)
H	L	M68 system DB0~15 16-bit parallel
H	H	M68 system DB0~7 8-bit parallel (connect unused pings to gnd)

7. 功能框图

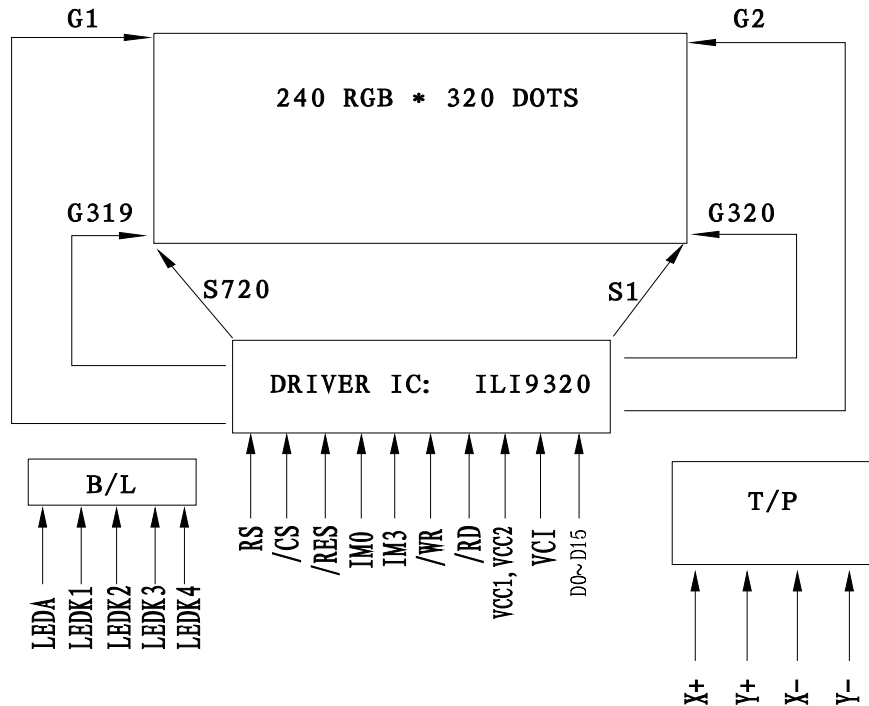

8. 接口时序

i80 18-/16-bit System Bus Interface Timing**(a) Write to register****(b) Read from register*****i80 9-/8-bit System Bus Interface Timing*****(a) Write to register****(b) Read from register**

9. 复位时序

Reset Timing Characteristics (VCC = 1.8 ~ 3.3 V, IOVCC = 1.65 ~ 3.3 V)

Item	Symbol	Unit	Min.	Typ.	Max.
Reset low-level width	t_{RES}	ms	1	-	-
Reset rise time	t_{RES}	μ s	-	-	10

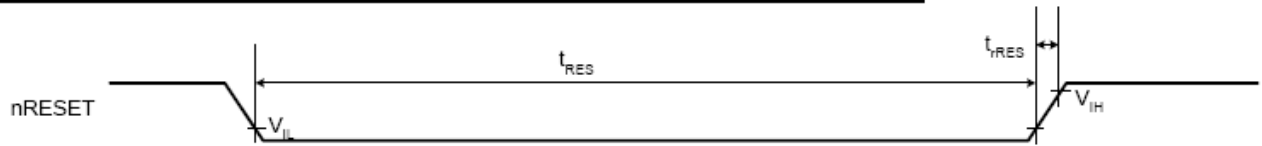

10.上/下线时序

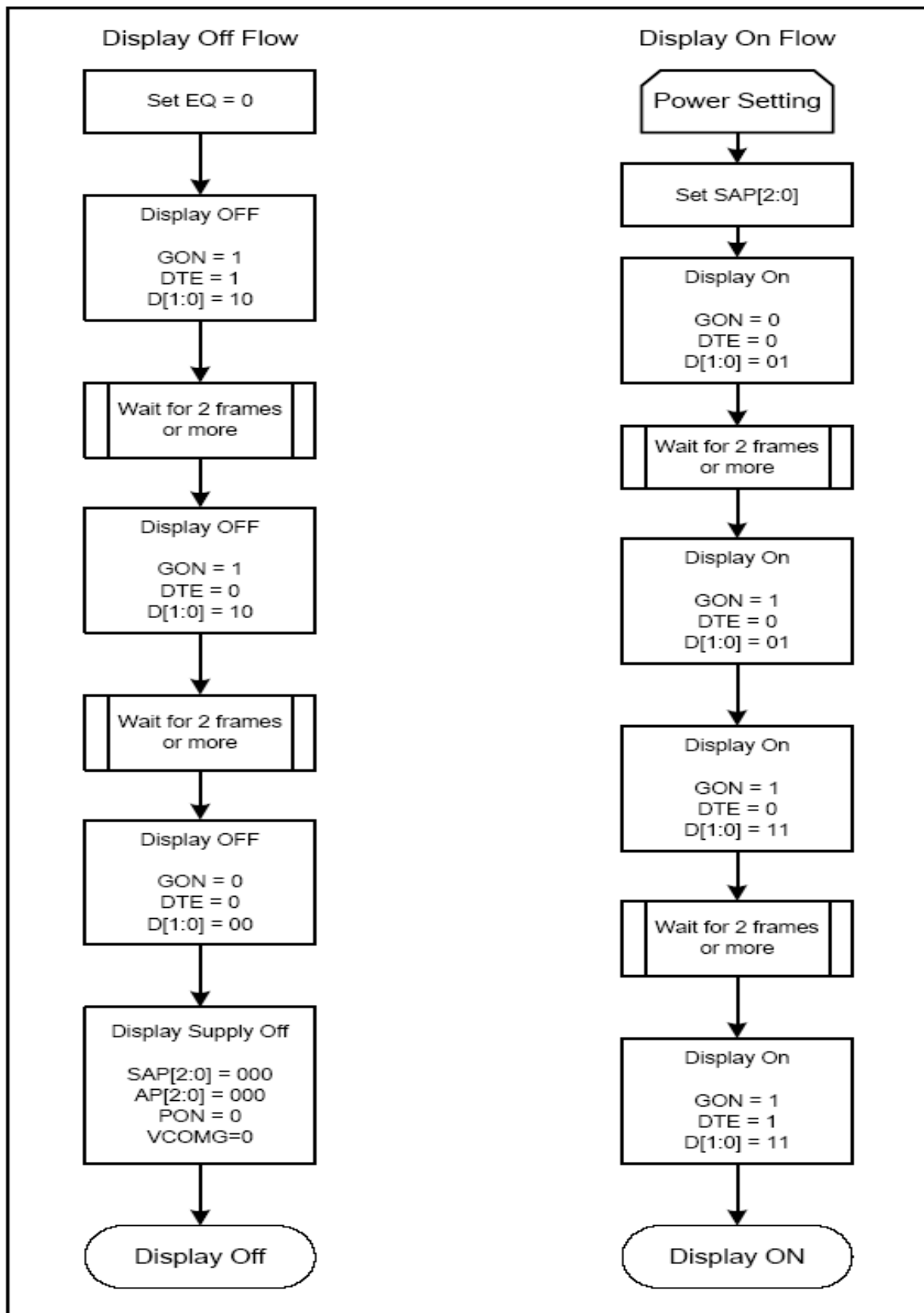

11. 指令表

No.	Registers Name	R/W	RS	D15	D14	D13	D12	D11	D10	D9	D8	D7	D6	D5	D4	D3	D2	D1	D0	
IR	Index Register	W	0	-	-	-	-	-	-	-	-	ID7	ID6	ID5	ID4	ID3	ID2	ID1	ID0	
SR	Status Read	R	0	L7	L6	L5	L4	L3	L2	L1	L0	0	0	0	0	0	0	0	0	
00h	Driver Code Read	R	1	1	0	0	1	0	0	1	0	0	0	1	0	0	0	1	0	
00h	Start Oscillation	W	1	-	-	-	-	-	-	-	-	-	-	-	-	-	-	-	OSC	
01h	Driver Output Control 1	W	1	0	0	0	0	0	SM	0	SS	0	0	0	0	0	0	0	0	
02h	LCD Driving Control	W	1	0	0	0	0	0	0	BC0	EOR	0	0	0	0	0	0	0	0	
03h	Entry Mode	W	1	TRI	DFM	0	BGR	0	DACKE	HWM	0	0	0	ID1	ID0	AM	0	0	0	
04h	Resize Control	W	1	0	0	0	0	0	0	RCV1	RCV0	0	0	RC11	RC10	0	0	RSZ1	RSZ0	
07h	Display Control 1	W	1	0	0	PTDE1	PTDE0	0	0	BASEE	0	0	0	GON	DTE	CL	0	D1	D0	
08h	Display Control 2	W	1	0	0	0	0	FP3	FP2	FP1	FP0	0	0	0	0	BP3	BP2	BP1	BP0	
09h	Display Control 3	W	1	0	0	0	0	0	PTS2	PTS1	PTS0	0	0	PTG1	PTG0	ISC3	ISC2	ISC1	ISC0	
0Ah	Display Control 4	W	1	0	0	0	0	0	0	0	0	0	0	0	0	FMARKOE	FMI2	FMI1	FMI0	
0Ch	RGB Display Interface Control 1	W	1	ENC2	ENC1	ENC0	0	0	0	0	RM	0	0	DM1	DM0	0	0	RIM1	RIM0	
0Dh	Frame Maker Position	W	1	0	0	0	0	0	0	0	FMP6	FMP7	FMP6	FMP5	FMP4	FMP3	FMP2	FMP1	FMP0	
0Fh	RGB Display Interface Control 2	W	1	0	0	0	0	0	0	0	0	0	0	VSPL	HSPL	0	0	DPL	EPL	
10h	Power Control 1	W	1	0	0	0	SAP	BT3	BT2	BT1	BT0	APE	AP2	AP1	AP0	0	DSTB	SLP	0	
11h	Power Control 2	W	1	0	0	0	0	0	DC12	DC11	DC10	0	DC02	DC01	DC00	0	VC2	VC1	VC0	
12h	Power Control 3	W	1	0	0	0	0	0	0	0	0	0	0	0	PON	VRH3	VRH2	VRH1	VRH0	
13h	Power Control 4	W	1	0	0	0	VDV4	VDV3	VDV2	VDV1	VDV0	0	0	0	0	0	0	0	0	
20h	Horizontal GRAM Address Set	W	1	0	0	0	0	0	0	0	0	AD7	AD6	AD5	AD4	AD3	AD2	AD1	AD0	
21h	Vertical GRAM Address Set	W	1	0	0	0	0	0	0	0	0	AD16	AD15	AD14	AD13	AD12	AD11	AD10	AD9	AD8
22h	Write Data to GRAM	W	1	RAM write data (WD17-0) / read data (RD17-0) bits are transferred via different data bus lines according to the selected interfaces.																
25h	Power Control 7	W	1	0	0	0	0	0	0	0	0	0	0	0	VCM4	VCM3	VCM2	VCM1	VCM0	
30h	Gamma Control 1	W	1	0	0	0	0	0	0	KP1[2]	KP1[1]	KP1[0]	0	0	0	0	0	KP0[2]	KP0[1]	KP0[0]
31h	Gamma Control 2	W	1	0	0	0	0	0	0	KP3[2]	KP3[1]	KP3[0]	0	0	0	0	0	KP2[2]	KP2[1]	KP2[0]
32h	Gamma Control 3	W	1	0	0	0	0	0	0	KP5[2]	KP5[1]	KP5[0]	0	0	0	0	0	KP4[2]	KP4[1]	KP4[0]
35h	Gamma Control 4	W	1	0	0	0	0	0	0	RP1[2]	RP1[1]	RP1[0]	0	0	0	0	0	RP0[2]	RP0[1]	RP0[0]
36h	Gamma Control 5	W	1	0	0	0	VRP1[4]	VRP1[3]	VRP1[2]	VRP1[1]	VRP1[0]	0	0	0	VRP0[4]	VRP0[3]	VRP0[2]	VRP0[1]	VRP0[0]	
37h	Gamma Control 6	W	1	0	0	0	0	0	KN1[2]	KN1[1]	KN1[0]	0	0	0	0	0	0	KN0[2]	KN0[1]	KN0[0]
38h	Gamma Control 7	W	1	0	0	0	0	0	KN3[2]	KN3[1]	KN3[0]	0	0	0	0	0	0	KN2[2]	KN2[1]	KN2[0]
39h	Gamma Control 8	W	1	0	0	0	0	0	KNS[2]	KNS[1]	KNS[0]	0	0	0	0	0	0	KN4[2]	KN4[1]	KN4[0]
3Ch	Gamma Control 9	W	1	0	0	0	0	0	RN1[2]	RN1[1]	RN1[0]	0	0	0	0	0	0	RN0[2]	RN0[1]	RN0[0]
3Dh	Gamma Control 10	W	1	0	0	0	VRN1[4]	VRN1[3]	VRN1[2]	VRN1[1]	VRN1[0]	0	0	0	VRN0[4]	VRN0[3]	VRN0[2]	VRN0[1]	VRN0[0]	

3Dh	Gamma Control 10	W	1	0	0	0	VRN1[4]	VRN1[3]	VRN1[2]	VRN1[1]	VRN1[0]	0	0	0	VRN0[4]	VRN0[3]	VRN0[2]	VRN0[1]	VRN0[0]			
50h	Horizontal Address Start Position	W	1	0	0	0	0	0	0	0	0	HSA7	HSA6	HSA5	HSA4	HSA3	HSA2	HSA1	HSA0			
51h	Horizontal Address End Position	W	1	0	0	0	0	0	0	0	0	HEA7	HEA6	HEA5	HEA4	HEA3	HEA2	HEA1	HEA0			
52h	Vertical Address Start Position	W	1	0	0	0	0	0	0	0	0	VSA8	VSA7	VSA6	VSA5	VSA4	VSA3	VSA2	VSA1	VSA0		
53h	Vertical Address End Position	W	1	0	0	0	0	0	0	0	0	VEA8	VEA7	VEA6	VEA5	VEA4	VEA3	VEA2	VEA1	VEA0		
60h	Driver Output Control 2	W	1	GS	0	NL5	NL4	NL3	NL2	NL1	NL0	0	0	SCN5	SCN4	SCN3	SCN2	SCN1	SCN0			
61h	Base Image Display Control	W	1	0	0	0	0	0	0	0	0	0	0	0	0	0	NDL	VLE	REV			
6Ah	Vertical Scroll Control	W	1	0	0	0	0	0	0	0	0	VL8	VL7	VL6	VL5	VL4	VL3	VL2	VL1	VL0		
80h	Partial Image 1 Display Position	W	1	0	0	0	0	0	0	0	0	PTDP08	PTDP07	PTDP06	PTDP05	PTDP04	PTDP03	PTDP02	PTDP01	PTDP00		
81h	Partial Image 1 Area (Start Line)	W	1	0	0	0	0	0	0	0	0	PTSA08	PTSA07	PTSA06	PTSA05	PTSA04	PTSA03	PTSA02	PTSA01	PTSA00		
82h	Partial Image 1 Area (End Line)	W	1	0	0	0	0	0	0	0	0	PTEA08	PTEA07	PTEA06	PTEA05	PTEA04	PTEA03	PTEA02	PTEA01	PTEA00		
83h	Partial Image 2 Display Position	W	1	0	0	0	0	0	0	0	0	PTDP18	PTDP17	PTDP16	PTDP15	PTDP14	PTDP13	PTDP12	PTDP11	PTDP10		
84h	Partial Image 2 Area (Start Line)	W	1	0	0	0	0	0	0	0	0	PTSA18	PTSA17	PTSA16	PTSA15	PTSA14	PTSA13	PTSA12	PTSA11	PTSA10		
85h	Partial Image 2 Area (End Line)	W	1	0	0	0	0	0	0	0	0	PTEA18	PTEA17	PTEA16	PTEA15	PTEA14	PTEA13	PTEA12	PTEA11	PTEA10		
90h	Panel Interface Control 1	W	1	0	0	0	0	0	0	DIV1	DIV0	0	0	0	0	RTN3	RTN2	RTN1	RTN0			
92h	Panel Interface Control 2	W	1	0	0	0	0	0	0	NOW2	NOW1	NOW0	0	0	0	0	0	0	0			
93h	Panel Interface Control 3	W	1	0	0	0	0	0	0	0	0	0	0	0	0	0	MCPI2	MCPI1	MCPI0			
95h	Panel Interface Control 4	W	1	0	0	0	0	0	0	0	0	0	0	0	0	0	RTNE5	RTNE4	RTNE3	RTNE2	RTNE1	RTNE0
97h	Panel Interface Control 5	W	1	0	0	0	0	0	0	NOWE3	NOWE2	NOWE1	NOWE0	0	0	0	0	0	0	0		
98h	Panel Interface Control 6	W	1	0	0	0	0	0	0	0	0	0	0	0	0	0	0	MCPE2	MCPE1	MCPE0		

12. DDRAM 映射表

GRAM address map table of SS=0, BGR=0

SS=0, BGR=0		S1...S3	S4...S6	S7...S9	S10...S12	...	S517...S519	S520...S522	S523...S525	S526...S720
GS=0	GS=1	DB17...0	DB17...0	DB17...0	DB17...0	...	DB17...0	DB17...0	DB17...0	DB17...0
G1	G320	"00000h"	"00001h"	"00002h"	"00003h"	...	"000ECh"	"000EDh"	"000EEh"	"000EFh"
G2	G319	"00100h"	"00101h"	"00102h"	"00103h"	...	"001ECh"	"001EDh"	"001EEh"	"001EFh"
G3	G318	"00200h"	"00201h"	"00202h"	"00203h"	...	"002ECh"	"002EDh"	"002EEh"	"002EFh"
G4	G317	"00300h"	"00301h"	"00302h"	"00303h"	...	"003ECh"	"003EDh"	"003EEh"	"003EFh"
G5	G316	"00400h"	"00401h"	"00402h"	"00403h"	...	"004ECh"	"004EDh"	"004EEh"	"004EFh"
G6	G315	"00500h"	"00501h"	"00502h"	"00503h"	...	"005ECh"	"005EDh"	"005EEh"	"005EFh"
G7	G314	"00600h"	"00601h"	"00602h"	"00603h"	...	"006ECh"	"006EDh"	"006EEh"	"006EFh"
G8	G313	"00700h"	"00701h"	"00702h"	"00703h"	...	"007ECh"	"007EDh"	"007EEh"	"007EFh"
G9	G312	"00800h"	"00801h"	"00802h"	"00803h"	...	"008ECh"	"008EDh"	"008EEh"	"008EFh"
G10	G311	"00900h"	"00901h"	"00902h"	"00903h"	...	"009ECh"	"009EDh"	"009EEh"	"009EFh"
.
.
.
G311	G10	"13600h"	"13601h"	"13602h"	"13603h"	...	"136ECh"	"136EDh"	"136EEh"	"136EFh"
G312	G9	"13700h"	"13701h"	"13702h"	"13703h"	...	"137ECh"	"137EDh"	"137EEh"	"137EFh"
G313	G8	"13800h"	"13801h"	"13802h"	"13803h"	...	"138ECh"	"138EDh"	"138EEh"	"138EFh"
G314	G7	"13900h"	"13901h"	"13902h"	"13903h"	...	"139ECh"	"139EDh"	"139EEh"	"139EFh"
G315	G6	"13A00h"	"13A01h"	"13A02h"	"13A03h"	...	"13AECh"	"13AEDh"	"13AEEh"	"13AEFh"
G316	G5	"13B00h"	"13B01h"	"13B02h"	"13B03h"	...	"13BECh"	"13BEDh"	"13BEEh"	"13BEFh"
G317	G4	"13C00h"	"13C01h"	"13C02h"	"13C03h"	...	"13CECh"	"13CEDh"	"13CEEh"	"13CEFh"
G318	G3	"13D00h"	"13D01h"	"13D02h"	"13D03h"	...	"13DECh"	"13DEDh"	"13DEEh"	"13DEFh"
G319	G2	"13E00h"	"13E01h"	"13E02h"	"13E03h"	...	"13EECh"	"13EEDh"	"13EEEh"	"13EEFh"
G320	G1	"13F00h"	"13F01h"	"13F02h"	"13F03h"	...	"13FECh"	"13FEDh"	"13FEEh"	"13FEFh"

13. 极限技术参数

项目	符号	条件	标准值			单位
			最小值	典型值	最大值	
逻辑电压	VDD	Ta=25°C	-0.3	—	4.6	V
输入电平	VIN	Ta=25°C	-0.3	—	VDD+0.3	V
使用温度	TOPR	----	-20	—	60	°C
存储温度	TSTG	----	-30	—	70	°C

14. 电气参数

项目	符号	条件	标准值			单位
			最小值	典型值	最大值	
逻辑电压	VDD	Ta= +25°C	---	2.8	----	V
输入高电平	VIH	—	0.8VDD	—	VDD	V
输入低电平	VIL	—	-0.3	—	0.2VDD	V
输出高电平	VOH	IOH=-100uA	0.8VDD	—	----	V
输出低电平	VOL	IOVCC=1.65~3.3V VCC= 2.4 ~ 3.3V IOL = 0.1mA	----	—	0.2VDD	V

15. 背光参数

15-1 背光供电方式

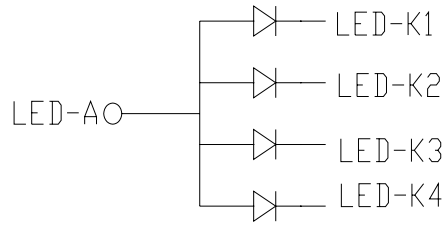

15-2 极限参数值

参数	符号	规格	单位
功耗	PD	380	mW
顺向电流	IFm	100	mA
反向电压	VR	5	V
操作温度	TOPR	-20℃ ~ +60℃	℃
储存温度	TSTG	-30℃ ~ +70℃	℃

15-3 电气参数

参数	符号	光源	条件	标准值			单位
				最小值	典型值	最大值	
驱动电压	Vf	WHITE	If =60mA	---	3.2	---	V
亮度	lv	WHITE		2800	3100	3400	cd/m ²
均匀度	lv-m	WHITE	(min/max)/100	80	----	----	%

16. 光电参数

Parameter	Symbol	Values			Unit	Notes
		Min	Typ	Max		
*1) Threshold Voltage	Vsat	2.0	2.1	2.2	V	Fig.2
	Vth	1.0	1.1	1.2	V	
*2) Transmittance	T(%)	-	13.3	-	%	Fig.1
*1) Contrast Ratio	C/R	300	350	-		
*1) Response Time	Tr+Tf	-	25	40	msec	Fig.3
*3) CIE Color Coordinate	Rx	0.631	0.651	0.671		
	Ry	0.311	0.331	0.351		
	Gx	0.281	0.301	0.321		
	Gy	0.565	0.585	0.605		
	Bx	0.113	0.133	0.153		
	By	0.116	0.136	0.156		
	Wx	0.289	0.309	0.329		
	Wy	0.324	0.344	0.364		
*1) Viewing Angle	Θ_l	45	-	-	Degree	C/R>10 Fig.4
	Θ_r	45	-	-		
	Θ_u	35	-	-		
	Θ_d	15	-	-		

Notes : 1. Contrast Ratio(CR) is defined mathematically as :

$$\text{Contrast Ratio} = \frac{\text{Surface Luminance with all white pixels}}{\text{Surface Luminance with all black pixels}}$$

2. Surface luminance is the center point across the TFT-LCD surface 500mm from the surface with a pixels displaying white. For more information see FIG 1.
3. Response time is the time required for the display to transition from white to black(Rise Time, Tr) and from black to white(Falling Time, Tf). For additional information see FIG 3.
4. Viewing angle is the angle at which the contrast ratio is greater than 10. The angles are determined for the horizontal or x axis and the vertical or y axis with respect to the z axis which is normal to the TFT-LCD surface. For more information see FIG 4.
5. Optimum contrast is obtained by adjusting the TFT-LCD Threshold voltage(Vth & Vsat)

FIG. 1 Optical Characteristic Measurement Equipment and Method

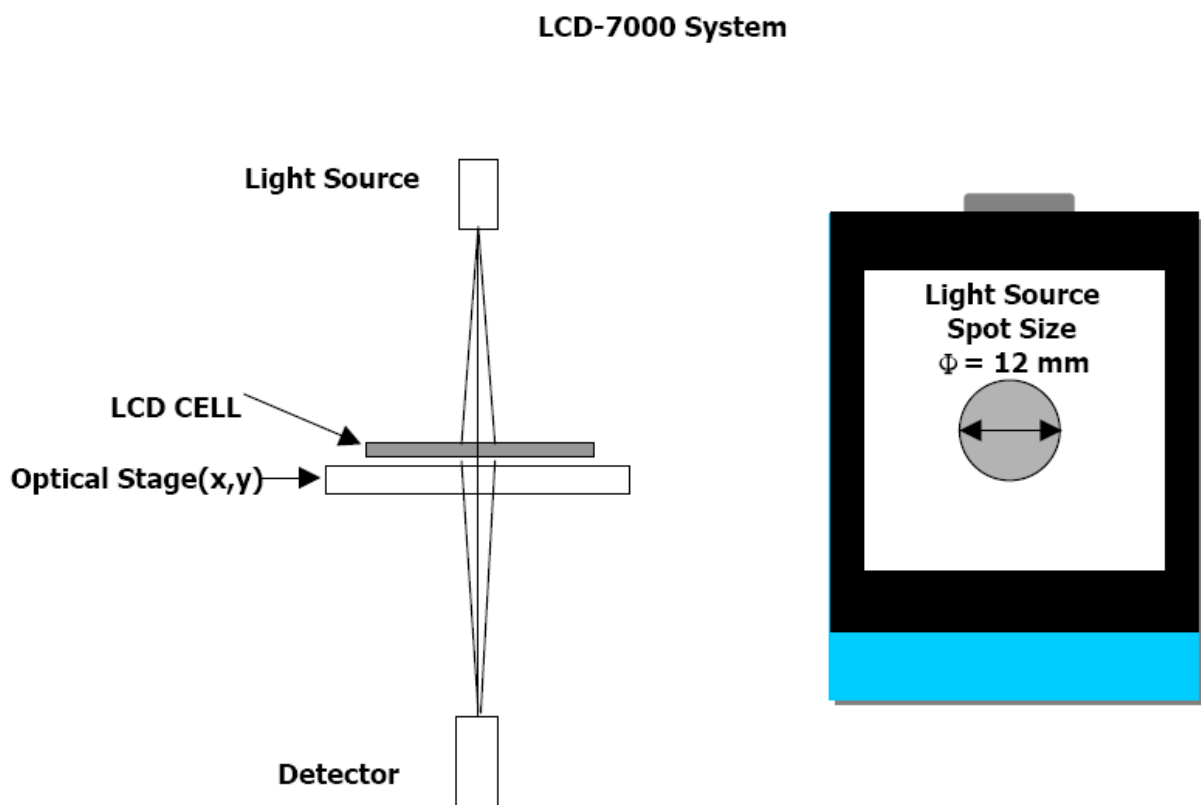
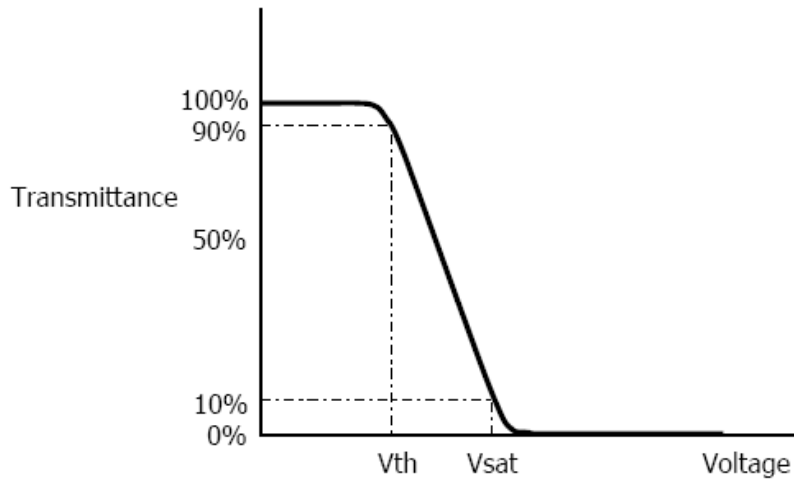
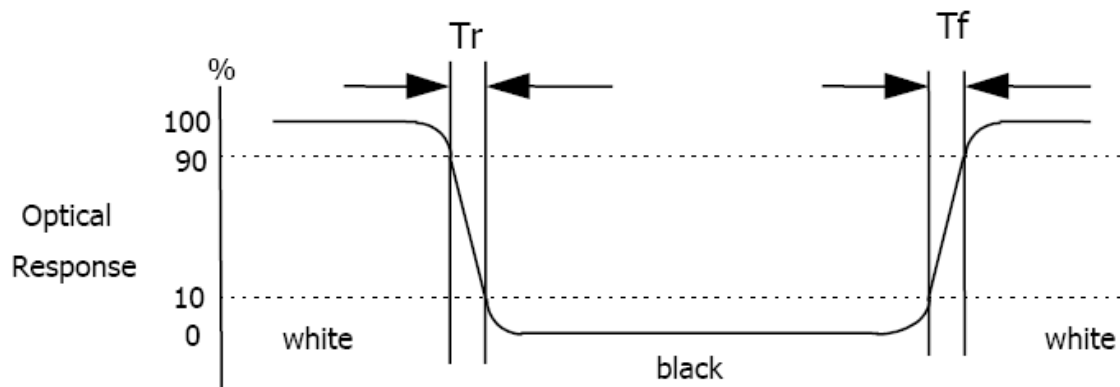

FIG. 2 The definition of V_{th} and V_{sat} **FIG. 3 The definition of Response Time**

The response time is defined as the following figure and shall be measured by switching the input signal for "black" and "white".



* Voltage conditions for Response time

V_{gate} : 19V DC

V_{data} : 0V~3.3V DC

V_{com} : 0V (Ground)

FIG. 4 The definition of viewing angle

<dimension of viewing angle range>

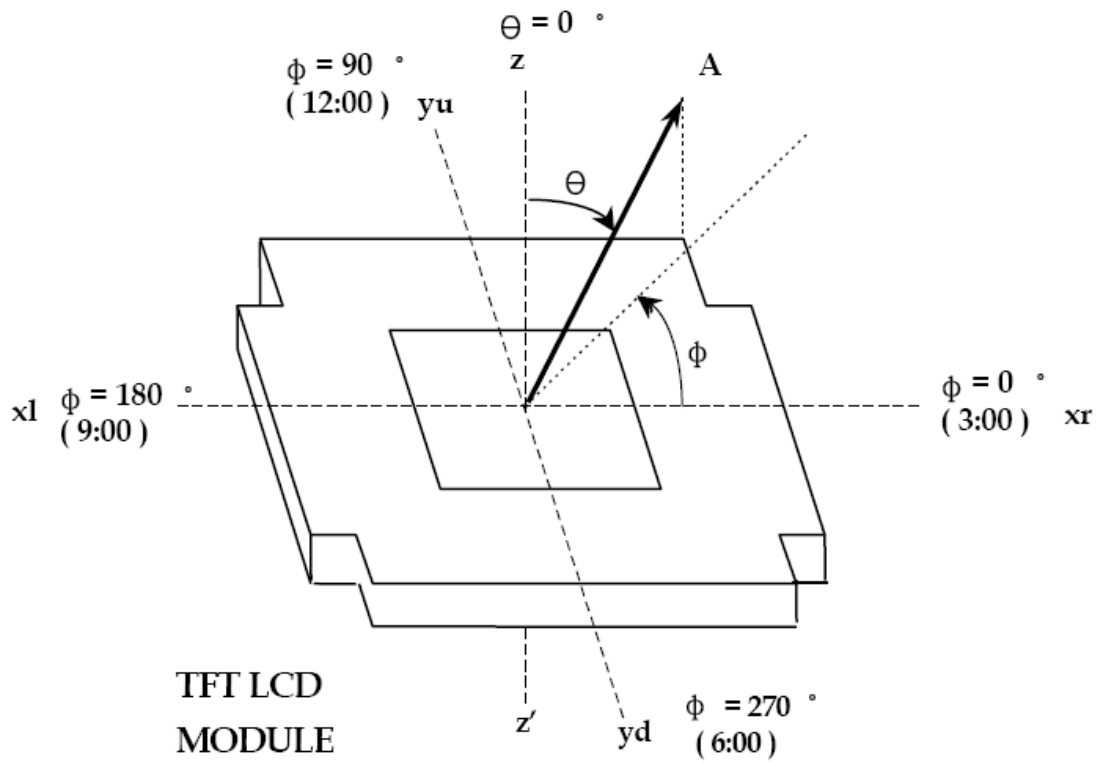

17. 极限环境参数

项目	符号	条件	标准
操作温度	TOPR	-20°C ~ +60°C	外观无缺陷, 功能正常
储存温度	TSTG	-30°C ~ +70°C	外观无缺陷, 功能正常
湿度	—	See Note	无缩合, 凝聚现象

NOTE: 测试条件

- (1) 温度和湿度: 25±2 °C, 60±5%RH (特殊条件除外)
- (2) 操作状态: 样品在正常工作时测试

18. 可靠性测试

项目	条件	标准
操作温度	高温 +60°C 72 小时	外观无缺陷, 功能正常
	低温 -20°C 72 小时	
储存温度	高温+70°C 120 小时	外观无缺陷, 功能正常
	低温 -30°C 120 小时	
恒温恒湿	40°C 90%RH 72HRS	外观无缺陷, 功能正常
振动	时间: 每个方向振动三十分钟 (X,Y,Z) 频率: 10~55Hz (1 min) 振幅: 1.5mm	外观无缺陷, 功能正常
冷热冲击	-20°C (30mins) ←→+60°C (30mins) 10 cycles	外观无缺陷, 功能正常

NOTE: 以上测试后须在室温放置 2 小时检查样品

19. LCM 检验标准

(1) 外观检验项目及标准 (非工作状态)

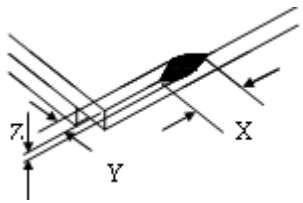
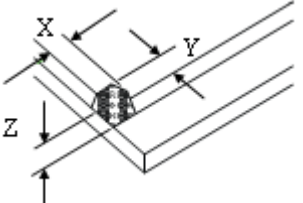
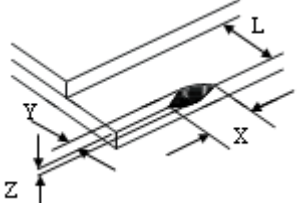
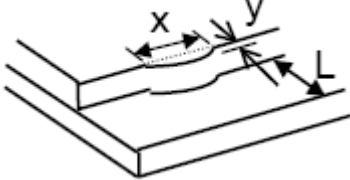
次序	项目	判断标准	AQL																						
1	尺寸状况	尺寸超出产品规格	1																						
2	缺口	<p>1、一般缺口</p>  <table border="1" style="margin-left: auto; margin-right: auto;"> <tr><td style="text-align: center;">X</td><td style="text-align: center;">Y</td><td style="text-align: center;">Z</td></tr> <tr><td style="text-align: center;">$\geq K/8$</td><td style="text-align: center;">不进入 A 区</td><td style="text-align: center;">$\leq T$</td></tr> </table> <p>2、角缺</p>  <table border="1" style="margin-left: auto; margin-right: auto;"> <tr><td style="text-align: center;">X</td><td style="text-align: center;">Y</td><td style="text-align: center;">Z</td></tr> <tr><td style="text-align: center;">$\geq K/8$</td><td style="text-align: center;">不进入 A 区</td><td style="text-align: center;">不计</td></tr> </table> <p>3、引脚部位缺口</p>  <table border="1" style="margin-left: auto; margin-right: auto;"> <tr><td style="text-align: center;">X</td><td style="text-align: center;">Y</td><td style="text-align: center;">Z</td></tr> <tr><td style="text-align: center;">$\geq K/8$</td><td style="text-align: center;">$\geq L/3$</td><td style="text-align: center;">不计</td></tr> </table> <p>4、边缘突起</p>  <table border="1" style="margin-left: auto; margin-right: auto;"> <tr><td style="text-align: center;">X</td><td style="text-align: center;">Y</td></tr> <tr><td style="text-align: center;">$\geq K/8$</td><td style="text-align: center;">$\geq L/3$</td></tr> </table> <p style="text-align: center;">缺口伤及线路斑马纸产品 $Y \leq L/5$；导电胶条产品 $Y \leq L/3$；装脚产品 $Y \leq 0.3\text{mm}$ 判断</p>	X	Y	Z	$\geq K/8$	不进入 A 区	$\leq T$	X	Y	Z	$\geq K/8$	不进入 A 区	不计	X	Y	Z	$\geq K/8$	$\geq L/3$	不计	X	Y	$\geq K/8$	$\geq L/3$	2.50
X	Y	Z																							
$\geq K/8$	不进入 A 区	$\leq T$																							
X	Y	Z																							
$\geq K/8$	不进入 A 区	不计																							
X	Y	Z																							
$\geq K/8$	$\geq L/3$	不计																							
X	Y																								
$\geq K/8$	$\geq L/3$																								

3	点状缺陷	 <p>X:长径 Y:短径 D:平均直径 $D=(X+Y)/2$</p>	<table border="1" style="width:100%; border-collapse: collapse;"> <thead> <tr> <th rowspan="2">D</th> <th colspan="2">允许缺陷数</th> </tr> <tr> <th>A/B 区</th> <th>C 区</th> </tr> </thead> <tbody> <tr> <td>$D < 0.2$</td> <td colspan="2">不限</td> </tr> <tr> <td>$0.2 \leq D < 0.3$</td> <td colspan="2">2</td> </tr> <tr> <td>$0.3 \leq D \leq 0.5$</td> <td colspan="2">1</td> </tr> <tr> <td>$D > 0.5$</td> <td colspan="2">0</td> </tr> </tbody> </table>	D	允许缺陷数		A/B 区	C 区	$D < 0.2$	不限		$0.2 \leq D < 0.3$	2		$0.3 \leq D \leq 0.5$	1		$D > 0.5$	0		2.50			
D	允许缺陷数																							
	A/B 区	C 区																						
$D < 0.2$	不限																							
$0.2 \leq D < 0.3$	2																							
$0.3 \leq D \leq 0.5$	1																							
$D > 0.5$	0																							
4	线状缺陷	 <p>L:长度 W:宽度 对偏光片（刮伤、污点、压痕）有限度样本则以限度样本判断</p>	<table border="1" style="width:100%; border-collapse: collapse;"> <thead> <tr> <th rowspan="2">长度</th> <th rowspan="2">宽度</th> <th colspan="2">允许缺陷数</th> </tr> <tr> <th>A/B 区</th> <th>C 区</th> </tr> </thead> <tbody> <tr> <td>不计</td> <td>$W \leq 0.02$</td> <td>不计</td> <td rowspan="2">不限</td> </tr> <tr> <td>$L \leq 3$</td> <td>$W \leq 0.05$</td> <td>2</td> </tr> <tr> <td rowspan="2">$L \leq 2.5$</td> <td>$W \leq 0.05$</td> <td>2</td> <td rowspan="2">按点状缺陷判定</td> </tr> <tr> <td>$W > 0.05$</td> <td></td> </tr> </tbody> </table>	长度	宽度	允许缺陷数		A/B 区	C 区	不计	$W \leq 0.02$	不计	不限	$L \leq 3$	$W \leq 0.05$	2	$L \leq 2.5$	$W \leq 0.05$	2	按点状缺陷判定	$W > 0.05$		2.50	
长度	宽度	允许缺陷数																						
		A/B 区	C 区																					
不计	$W \leq 0.02$	不计	不限																					
$L \leq 3$	$W \leq 0.05$	2																						
$L \leq 2.5$	$W \leq 0.05$	2	按点状缺陷判定																					
	$W > 0.05$																							
5	偏光片 气泡/水纹/皱纹		<table border="1" style="width:100%; border-collapse: collapse;"> <thead> <tr> <th rowspan="2">D</th> <th colspan="2">允许缺陷数</th> </tr> <tr> <th>A/B 区</th> <th>C 区</th> </tr> </thead> <tbody> <tr> <td>$D \leq 0.2$</td> <td colspan="2">不限</td> </tr> <tr> <td>$0.2 \leq D \leq 0.5$</td> <td colspan="2">3 个</td> </tr> <tr> <td>$0.5 \leq D \leq 1.0$</td> <td colspan="2">2 个</td> </tr> <tr> <td>$D > 1.0$</td> <td colspan="2">0 个</td> </tr> </tbody> </table>	D	允许缺陷数		A/B 区	C 区	$D \leq 0.2$	不限		$0.2 \leq D \leq 0.5$	3 个		$0.5 \leq D \leq 1.0$	2 个		$D > 1.0$	0 个		2.50			
D	允许缺陷数																							
	A/B 区	C 区																						
$D \leq 0.2$	不限																							
$0.2 \leq D \leq 0.5$	3 个																							
$0.5 \leq D \leq 1.0$	2 个																							
$D > 1.0$	0 个																							
6	外丝印	1、丝印变形、针孔：按照字符变形针孔规格判断。 2、丝印宽度：丝印宽度 $\geq 1/2$ 标准宽度，可判 OK。		2.50																				
7	打胶（硅胶）	打胶面积必须盖住 ITO 引线		2.50																				
8	PCB 板不良	1、PCB 板烧焦、版本不符、线路剥离、裂痕、导电过孔堵不允许 2、PCB 板金手指不可有氧化、腐蚀、胶状物、断裂现象		2.50																				
9	贴片元件	1、元件装配上下、左右偏位 $\leq 1/3$ 元件本体宽度 2、焊锡点尽可能光滑圆润 3、元件受损、破裂、少件、多件、元件装配反向、漏焊不允许		2.50																				
10	铁框	破裂、变形不允许 外形尺寸参照产品规格书		2.50																				

(2) 显示功能检验项目及标准（工作状态）

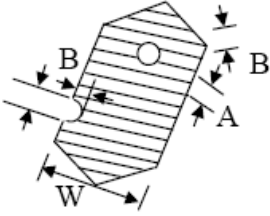
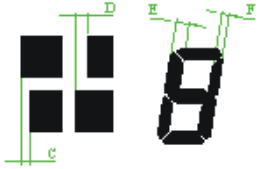
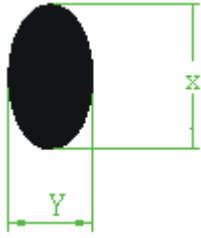
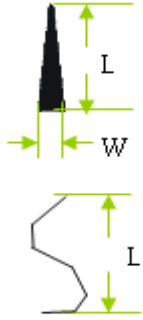
1	电性能缺陷		<table border="1" style="width:100%; border-collapse: collapse;"> <tr><td style="width:30%;">断路</td><td style="width:70%;">不允许</td></tr> <tr><td>短路/大电流</td><td>不允许</td></tr> <tr><td>视角错误</td><td>不允许</td></tr> </table>	断路	不允许	短路/大电流	不允许	视角错误	不允许	1.0													
断路	不允许																						
短路/大电流	不允许																						
视角错误	不允许																						
2	字划 凸起/缺口	<p>1、针孔缺口</p>  <table border="1" style="width:100%; border-collapse: collapse;"> <tr><th style="width:30%;">宽度</th><th style="width:70%;">接收规格</th></tr> <tr><td>$W < 0.4$</td><td>$D \leq 0.2$ & $D \leq 1/2W$</td></tr> <tr><td>$W \geq 0.4$</td><td>$D \leq 0.25$ & $D \leq 1/3W$</td></tr> </table> <p>* $D = (A+B)/2$ $D \leq 0.1$ 则忽略不计</p>	宽度	接收规格	$W < 0.4$	$D \leq 0.2$ & $D \leq 1/2W$	$W \geq 0.4$	$D \leq 0.25$ & $D \leq 1/3W$	2.50														
宽度	接收规格																						
$W < 0.4$	$D \leq 0.2$ & $D \leq 1/2W$																						
$W \geq 0.4$	$D \leq 0.25$ & $D \leq 1/3W$																						
34	字划/图案 粗细	 <table border="1" style="width:100%; border-collapse: collapse;"> <tr><th style="width:30%;">宽度</th><th style="width:70%;">接收规格</th></tr> <tr><td>$W < 0.4$</td><td>$C, D, G \leq 1/2W$</td></tr> <tr><td>$W \geq 0.4$</td><td>$C, D, G \leq 0.2$</td></tr> </table> <p style="text-align:center;">W: 图案设计尺寸 C, D: 差异尺寸 $G = E-F$</p>	宽度	接收规格	$W < 0.4$	$C, D, G \leq 1/2W$	$W \geq 0.4$	$C, D, G \leq 0.2$	1.0														
宽度	接收规格																						
$W < 0.4$	$C, D, G \leq 1/2W$																						
$W \geq 0.4$	$C, D, G \leq 0.2$																						
4	点状缺陷	 <table border="1" style="width:100%; border-collapse: collapse;"> <tr><th rowspan="2" style="width:20%;">D</th><th colspan="2" style="width:80%;">允许缺陷数</th></tr> <tr><th style="width:30%;">A/B 区</th><th style="width:50%;">C 区</th></tr> <tr><td>$D < 0.1$</td><td>不限</td><td rowspan="4" style="text-align:center; vertical-align:middle;">不限</td></tr> <tr><td>$0.1 \leq D < 0.2$</td><td>2</td></tr> <tr><td>$0.2 \leq D \leq 0.25$</td><td>1</td></tr> <tr><td>$D > 0.25$</td><td>0</td></tr> </table> <p>X:长径 Y:短径 D:平均直径 $D = (X+Y)/2$ 如黑点、污迹在字段区, 按“笔段缺陷”判定</p>	D	允许缺陷数		A/B 区	C 区	$D < 0.1$	不限	不限	$0.1 \leq D < 0.2$	2	$0.2 \leq D \leq 0.25$	1	$D > 0.25$	0	2.50						
D	允许缺陷数																						
	A/B 区	C 区																					
$D < 0.1$	不限	不限																					
$0.1 \leq D < 0.2$	2																						
$0.2 \leq D \leq 0.25$	1																						
$D > 0.25$	0																						
5	线状缺陷	 <table border="1" style="width:100%; border-collapse: collapse;"> <tr><th rowspan="2" style="width:20%;">长度</th><th rowspan="2" style="width:20%;">宽度</th><th colspan="2" style="width:60%;">允许缺陷数</th></tr> <tr><th style="width:30%;">A/B 区</th><th style="width:30%;">C 区</th></tr> <tr><td>不计</td><td>$W \leq 0.02$</td><td>不计</td><td rowspan="3" style="text-align:center; vertical-align:middle;">不限</td></tr> <tr><td>$L \leq 3$</td><td>$W \leq 0.03$</td><td>2</td></tr> <tr><td rowspan="2">$L \leq 2.5$</td><td>$0.03 < W \leq 0.05$</td><td>2</td></tr> <tr><td>$W > 0.05$</td><td colspan="2">按点状缺陷判定</td></tr> </table> <p>L:长度 W:宽度</p>	长度	宽度	允许缺陷数		A/B 区	C 区	不计	$W \leq 0.02$	不计	不限	$L \leq 3$	$W \leq 0.03$	2	$L \leq 2.5$	$0.03 < W \leq 0.05$	2	$W > 0.05$	按点状缺陷判定		2.50	
长度	宽度	允许缺陷数																					
		A/B 区	C 区																				
不计	$W \leq 0.02$	不计	不限																				
$L \leq 3$	$W \leq 0.03$	2																					
$L \leq 2.5$	$0.03 < W \leq 0.05$	2																					
	$W > 0.05$	按点状缺陷判定																					

20. LCM 的使用

20-1 液晶显示模块

标准文本	产品规格书	型号	S95192	页数	22
------	-------	----	--------	----	----

LCD 是由玻璃和偏光片组成，在搬运过程中，请注意以下事项：

- (1) 请保证使用和存储是在规定的温度范围之内。高温高湿会导致偏光性能降级，产生气泡或者偏光片剥落。
- (2) LCM 表面的偏光片质软容易划伤,不要用硬度大于 HB 铅笔芯的任何物品（玻璃，镊子等）接触，挤压或者摩擦外露的偏光片
- (3) 用来粘合底/面偏光片和反射片的有机粘合剂会被一些化学物质，如丙酮，甲苯，乙醇和异链烷烃破坏，建议用 N-己烷进行清洁。
- (4) 显示屏表面有脏污，请吹拂同时用干的软布擦拭表面。如果脏污比较严重，建议用脱脂棉或者其他的柔软材料，如擦拭用软皮，浸湿异丙醇或酒精之后进行擦拭其表面。不要用力擦洗以避免损伤显示屏表面。
- (5) 不可使用以下溶剂：水，酮，芳香烃。其溶剂可能损坏偏光片。
- (6) 避免与油和脂肪接触。
- (7) 因低温而产生的表面浓缩和端子的连接，会损坏，染污或者弄脏偏光片。产品在低温测试之后，需要先在容器之内烘干之后才可以与室温接触。
- (8) 不要放置或贴附任何东西在屏幕上，以免留下痕迹。
- (9) 不要裸手触摸显示器。这样会染污显示区域，并且降低接线端子之间的绝缘性（对于偏光片一些化妆品是确定的）
- (10) 采取措施尽量减小电极的腐蚀。水滴，凝结的潮气或者高湿环境下的电流会加速电极的腐蚀。
- (11) 因为玻璃是易碎的，搬运过程中容易产生缺口（特别是边缘）。请避免跌落或震动。

20-2 组装 LCM 的注意事项

因为 LCM 是高精密度的组装和调试，请避免因过度的撞击，或者进行任何的变更或者修改。

- (1) 不要更改或者改变金属框架的突起形状。
- (2) 不要在线路印刷板上另外钻孔，修改形状或者改变其上的元器件的位置。
- (3) 不要损坏或者修改线路印刷板上的图案。
- (4) 绝对不要更改斑马条（导电橡胶）或者热压连接器。
- (5) 除了焊接接口，不要用烙铁进行任何的修改或者变更。
- (6) 不要跌落，弯曲或者扭转 LCM。特别注意不可用力拉或者扭转 I/O 口或背光的排线。
- (7) 为了防止 FPC 破裂，请特别注意 FPC 的可弯曲部分，覆盖层的边缘，镀金区域的表面，焊接区域或者通孔区域。

20-3 静电放电控制

因为模块使用 CMOS LSI,像平常的 CMOS IC 一样需要注意静电的防护。

- (1) 手持 LCM 时，请确保身体是接地的。为了尽量减少因静电而产生的 LCM 功能降级，在运输模块时小心操作避免接触到：印刷电路板的外露区域，元件的电极。
- (2) 从包装袋中取出 LCM 或者与其他装置装配时，请确保模块与你的身体的电势一致。
- (3) 焊接 LCM 的接线端时，请确保烙铁的交流电源没有漏电。
- (4) 使用电动螺丝批装配 LCM 时，电动螺丝批须接地以尽可能减小马达换向器产生火花而引起的电磁波辐射
- (5) 尽量使你的工衣，工作台达到地电位。
- (6) 为了减少静电产生需要注意工作环境的空气不可太干燥。建议相对湿度为 50%-60%。

20-4 操作注意事项：

- (1) 液晶的视角会随着驱动电压（VO）的变化而变化，调节 VO 使之显示为最好的对比度。
- (2) 极限值以上的驱动电压会缩短 LCD 的使用寿命。

标准文本	产品规格书	型号	S95192	页数	23
------	-------	----	--------	----	----

- (3) 如果 LCM 长时间的显示一个图案，图案可能残存（似鬼影）或者其暗影不规则的显示。隔段时间后使用即可恢复正常。请注意这种现象不会影响显示。
- (4) 在低于操作温度范围的温度下工作会造成响应时间延长。但是，这并不意味着 LCD 不能工作。它会在温度恢复至规定范围后恢复正常。
- (5) 如果在工作过程中显示区域被猛烈的挤压，显示会异常。但是，关电后重新启动后会恢复正常。
- (6) 端子的凝结水汽会导致电化学反应，破坏线路的接线端。所以，必须在低于 40°C，50% RH 环境条件下中使用。
- (7) 电源打开，在正极/负极电压稳定之后，输入信号。

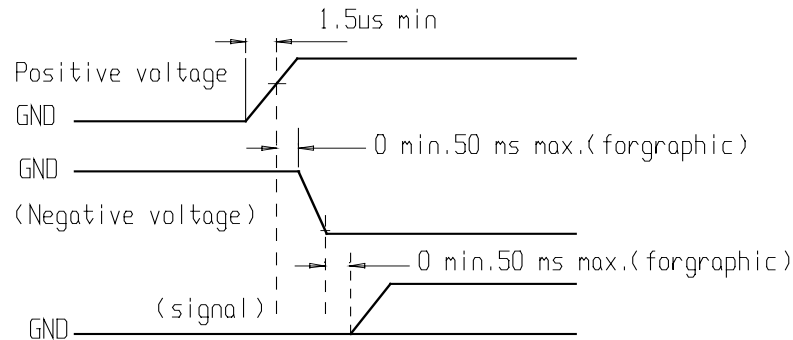

20-5 储存

如果 LCD 需储存几年，以下的预防事项是必要的。

- (1) 保存于密封的聚乙烯袋内。适当的密封就不需要干燥剂。
- (2) 存储于黑暗的环境中。不要暴露于日光或者荧光灯的直射下，保持温度在 0°C 到 35°C 之间。
- (3) 偏光片的表面不可与其他物体接触。（建议存于运输用的容器中）
- (4) 环境条件
 - 不要在 70°C 的环境中放置超过 160 小时。
 - 不要在 -20°C 的环境中放置超过 48 小时。

20-6 安全

- (1) 建议将损坏的或者不要的 LCD 压成碎片，用溶剂，如丙酮，乙醇清洗后烧毁。
- (2) 如果从破损的玻璃中泄漏的液晶不慎粘到手，请用肥皂，清水彻底清洗。

20-7 权利限制

除非经过宇顺公司和客户的认可，在交货之日起一年之内，宇顺公司会按照自己承诺的检验标准对 LCD 功能性的缺陷进行修改。外观上缺陷的产品必须在交货之日起 90 天之内退回宇顺公司。以上日期依运输文件为准。宇顺公司的权力范围仅限于对以上项目的修复和/或者替换。宇顺公司不会对由此引起的或者并发的其他事件负责。

20-8 权利范围之内的退货

如有违反以上所提到的预防注意事项而造成的不良将不予以保证。典型例子如下：

- 破坏 LCD 玻璃。
- 任何形式的线路修改，包括增加电器元件。

模块的修改必须基于客户相互的文件协议。模块退回时，必须要有详细的不良描述。客户安装的连接或者排线必须完全地取掉，不能损坏 LCM 的 PCB 孔，连接器和接线端。